



# Vet. Surgical Resources

*Quality Products for Veterinary Surgery*

- Custom Draping
- Custom Kit Packing
- OR Supplies
- Surgical Apparel

800-354-8501

[www.vetsurgicalresources.com](http://www.vetsurgicalresources.com)

## Our Mission Statement -

**Vet. Surgical Resources, Inc. was founded in 1992 to offer useful and innovative products for both large and small animal surgical procedures.**

**We are dedicated to that end, offering quality products without compromise while recognizing the economics of the veterinary market.**

---

### Table of Contents

---

About Vet. Surgical Resources' Products	1
Unfenestrated Drapes	3
Small Animal Specialty Sheets	4
Small Animal Procedure Kits	7
Equine Orthopedic Drapes	9
Large Animal Specialty Sheets	11
Large Animal Orthopedic Kits	12
Large Animal Laparotomy Sheets	13
Split Sheets / Incise Drapes / Impervious Stockinette	14
Towel Drapes / Table Covers/ Sponges	15
O. R. Gowns	16
O. R. Apparel	18
Equipment Covers	19
Suction Components / Misc.	20

For pricing information, please refer to our current price list or call.

Vet. Surgical Resources, Inc.  
PO Box 368  
Darlington, MD 21034

Phone, Continental USA & Canada: 1-800-354-8501  
Fax: 410-457-5373

Web Site: [www.vetsurgicalresources.com](http://www.vetsurgicalresources.com)  
Email: [wecare@vetsurgicalresources.com](mailto:wecare@vetsurgicalresources.com)

Ioban 2 and Steri-Drape are trademarks of 3M Healthcare.  
Dextex is a trademark of Ahlstrom Windsor Locks.

---

## About Vet. Surgical Resources' Products

Vet. Surgical Resources offers an extensive line of disposable drapes for both small and large animal surgical procedures. To assist you in making the best choice for your needs, please see the general information below, regarding materials, construction, and sterilization of our products.

**Sterilization** – Sterile products offered by Vet. Surgical Resources are either ETO or gamma sterilized with careful laboratory control and traceability to ensure sterility. Drapes and kits are over-wrapped and placed in either header pouches or peel-pouches for sterilization.

**Quality control** – We process all of our products in adherence with a rigorous quality control system, ensuring that our customers may use our products with confidence.

**Drape folding** – Drapes are fan-folded and open to the short dimension first. Drapes folded to open to the long dimension first are noted in the drape descriptions and by the addition of the suffix “-1” to the product number. For example, 6011-1 denotes a 55” X 77” drape opening to the long dimension first. An “A” in the drape number indicates Impervex material with the poly side folded away from the patient.

**Non-sterile products** – Many Vet. Surgical Resources drapes may be purchased non-sterile for practices wishing to assemble their own kits. Drapes of spunlace medical fabric, SMS, and wetlaid may be either ETO sterilized or autoclaved. Products made from our Impervex material must be either ETO or gamma sterilized.

**Special drapes and custom kits** – To meet your special needs, we would be happy to provide quotes on kits of drapes and other components as well as drape configurations not shown here.

**Specifications** – We continue to improve our products and reserve the right to change the specifications of our products without notice. For our most up to date product listings please view our online catalog at [www.vetsurgicalresources.com](http://www.vetsurgicalresources.com).

### **Materials** –

**Spunlace medical fabric** – This spunlaced material is widely used in both drapes and gowns in the human field. Because of its softness, Spunlace medical fabric has excellent draping characteristics and will resist tearing when fenestrated for surgery. Spunlace medical fabric is not impervious, but is treated to minimize moisture penetration. Autoclavable.

**Impervex medical fabric, Vet. Surgical Resources' impervious material** – Spunlace medical fabric laminated with polyethylene film. Our Impervex material builds on the draping qualities of spunlace medical fabric by adding a completely impervious film. This film is an effective viral barrier, reduces linting, and aids in forming a seal at the surgical site when fenestrated at the time of surgery.

**SMS material** – This material is formed from three layers of polypropylene fibers welded together to form the completed product. It exhibits good tear resistance, low linting, and is treated for moisture resistance. Autoclavable.

**Wetlaid non-woven material** – This material is widely used in the human field for both main drapes and towel drapes. Caution is required when fenestrating for surgery because of its low tear resistance. This material is treated for moisture resistance. Autoclavable.

**Plastic material** – Plastics are completely impervious. Color is noted in product descriptions.

**Thermoplastic elastomer** – This elastomeric material is used to make the conformable panels of the arthroscopy drapes. It has excellent stretch capability and forms a seal around the limb to control fluid during surgery.

**Adhesive** – Adhesive areas in our drapes are 3M adhesive squares.

### ***Reinforcement materials –***

Absorbent non-woven – This material will absorb fluids but maintains a very high wet strength. The underside of this material has a poly film coating so that collected fluids will not strike-through to the drape itself.

Polyfoam – This closed cell polyurethane foam has good strength along with a non-skid surface for instruments. Closed cell foam will not absorb moisture.

Impervious non-woven – Impervex material with the plastic film exposed. Used in our larger laparotomy sheets, it minimizes sticking of the bowel when used for equine colic surgery.



## Unfenestrated Drapes

Unfenestrated drapes are available wrapped and sterile or non-sterile. For non-sterile drapes add "NS" to the product number. These drapes may also be included in custom kits. Call for details.

### **Unfenestrated Spunlace Medical Fabric Drapes**

Fan-folded. Autoclavable.

Size (in.)	Size (cm)	Product Number
44 X 55	112 X 140	6010-1 <sup>1</sup>
40 X 77	102 X 196	6013
55 X 55	140 X 140	6017
55 X 77	140 X 196	6011-1 <sup>1</sup>
77 X 100	196 X 264	6012-1 <sup>1</sup>
77 X 120	196 X 305	6014

### **Unfenestrated Impervex Medical Fabric Drapes**

Fan-folded. Available sterile only.

Size (in.)	Size (cm)	Product Number
40 X 40	102 X 107	3005A <sup>2</sup>
40 X 60	102 X 152	3010
40 X 60	102 X 152	3010-1 <sup>1</sup>
40 X 80	102 X 203	3015
60 X 60	152 X 152	3011A <sup>2</sup>
60 X 80	152 X 203	3020A <sup>2</sup>
60 X 80	152 X 203	3020A-1 <sup>1,2</sup>
80 X 104	203 X 264	3012A-1 <sup>1,2</sup>
80 X 120	203 X 305	3025
140 X 160	356 X 406	3030 <sup>3</sup>
140 X 210	356 X 533	3035
160 X 240	406 X 610	3036

### **Unfenestrated SMS Drapes**

Fan-folded.

Size (in.)	Size (cm)	Product Number
40 X 42	102 X 107	6081
44 X 53	112 X 135	6082-1 <sup>1</sup>
53 X 75	135 X 191	6083-1 <sup>1</sup>
70 X 100	178 X 254	6084-1 <sup>1</sup>

### **Bulk Drape Material**

Product No. 3215

Spunlace medical fabric drape material. 55" x 100 yds. (140 cm X 91 m)/roll. Autoclavable.

### **Plastic Drapes**

Product No. 5162-1

43" X 74" (109 cm X 188 cm) blue poly utility drape. Sterile.

Product No. 6070

48" X 48" (122 cm X 122 cm) opaque poly drape. Sterile.

Product No. 6072

48" X 100" (122 cm X 254 cm) opaque poly drape. Sterile.

Product No. 6063

24" X 24" (61 cm X 61cm) opaque poly drape. 5" X 5" (13 cm X 13 cm) unfenestrated adhesive square centered on drape. Sterile.

### **Unfenestrated Specialty Sheets**

Product No. 6041

80" X 130" (203 cm X 330 cm) unfenestrated drape. 80" X 46" (51 cm X 76 cm) clear plastic anesthesia window. Sterile.

Notes:

<sup>1</sup> Drape opens to long dimension first.

<sup>2</sup> Drape folded poly side away from patient

<sup>3</sup> Copelan sheet

## Small Animal Specialty Sheets

The drapes featured on this page are constructed using our Impervex material and clear plastic. The Impervex material provides superior barrier properties and excellent fluid control. The clear plastic anesthesia window is located at the head end of the drape to allow the surgeon or technician to monitor the patient without moving the drape. Drapes are available in both orthopedic and laparoscopic configurations as well as unfenestrated (previous page).

### Small Animal Arthroscopy Sheets

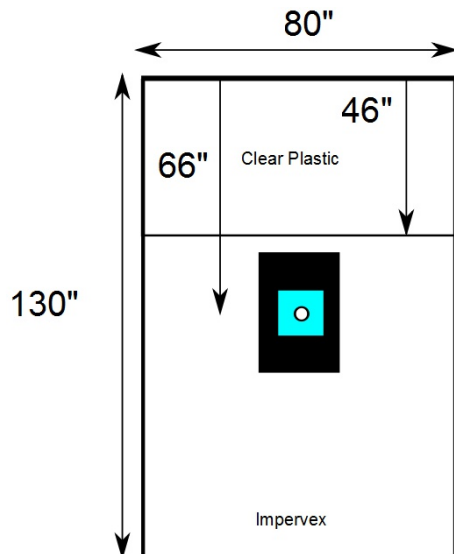

Product No. 6042 (not pictured)  
80" X 130" (203 cm X 330 cm) drape with 8" X 8" (20 cm X 20 cm) conformable panel and 2" (5 cm) fenestration. 20" X 30" (51 cm X 76 cm) absorbent reinforcement. 80" X 46" (203 cm X 117 cm) clear plastic anesthesia window. Sterile.

Product No. 6043 (pictured at left)  
80" X 130" (203 cm X 330 cm) drape with 8" X 8" (20 cm X 20 cm) conformable panel and 3-1/2" (9 cm) fenestration. 20" X 30" (51 cm X 76 cm) absorbent reinforcement. 80" X 46" (203 cm X 117 cm) clear plastic anesthesia window. Sterile.

Product No. 6044 (not pictured)  
80" X 130" (203 cm X 330 cm) drape with 8" X 8" (20 cm X 20 cm) conformable panel and 5" (13 cm) fenestration. 20" X 30" (51 cm X 76 cm) absorbent reinforcement. 80" X 46" (203 cm X 117 cm) clear plastic anesthesia window. Sterile.

Product No. 6046 (not pictured)  
80" X 130" (203 cm X 330 cm) drape with 9" X 9" (23 cm X 23 cm) conformable panel and 6" (15 cm) fenestration. 20" X 30" (51 cm X 76 cm) absorbent reinforcement. 80" X 46" (203 cm X 117 cm) clear plastic anesthesia window. Sterile.

Product No. 6048 (not pictured)  
80" X 130" (203 cm X 330 cm) drape with 16" X 16" (41 cm X 41 cm) conformable panel and 10" (25 cm) fenestration. 20" X 30" (51 cm X 76 cm) absorbent reinforcement. 80" X 46" (203 cm X 117 cm) clear plastic anesthesia window. Sterile.

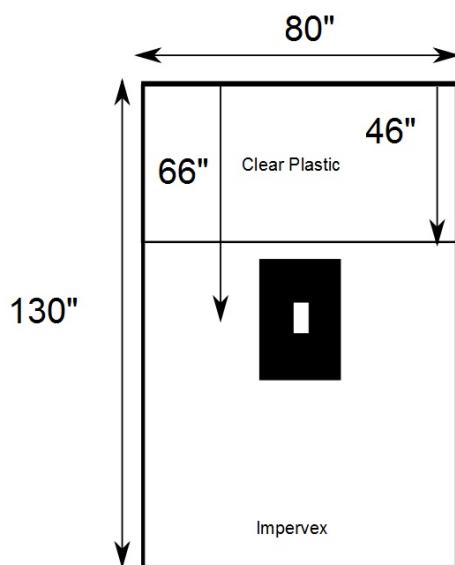

### Small Animal Laparotomy Sheets

Product No. 6049 (not pictured)  
80" X 130" (203 cm X 330 cm) drape with 20" X 30" (51 cm X 76 cm) absorbent reinforcing and 4" X 6" (10 cm X 15 cm) fenestration. 80" X 46" (203 cm X 117 cm) clear plastic anesthesia window. Sterile.

Product No. 6050 (pictured at left)  
80" X 130" (203 cm X 330 cm) drape with 20" X 30" (51 cm X 76 cm) absorbent reinforcing and 4" X 8" (10 cm X 20 cm) fenestration. 80" X 46" (203 cm X 117 cm) clear plastic anesthesia window. Sterile.

Product No. 6051 (not pictured)  
80" X 130" (203 cm X 330 cm) drape with 20" X 30" (51 cm X 76 cm) absorbent reinforcing and 4" X 12" (10 cm X 30 cm) fenestration. 80" X 46" (203 cm X 117 cm) clear plastic anesthesia window. Sterile.

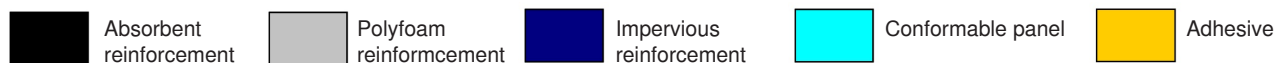

## Small Animal Specialty Sheets

Product No. 3021 (pictured at right)

60" X 80" (152 cm X 203 cm) Impervex drape with 20" X 30" (51 cm X 76 cm) absorbent reinforcement and 3" X 6" (8 cm X 15 cm) fenestration. Sterile.

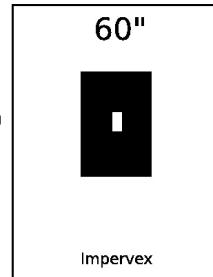

Product No. 3023-1 (not pictured)

60" X 77" (152 cm X 196 cm) spunlace drape with 20" X 30" (51 cm X 76 cm) absorbent reinforcement and 4" X 8" (10 cm X 20 cm) fenestration with adhesive. Sterile.

Product No. 3016 (pictured at left)

40" X 80" (102 cm X 203 cm) Impervex drape with 20" X 30" (51 cm X 76 cm) absorbent reinforcement and 4" X 6" (10 cm X 15 cm) fenestration. Sterile.

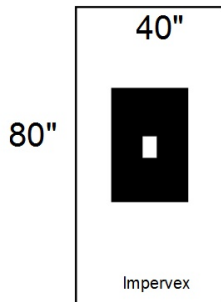

Product No. 3024-1 (not pictured)

60" X 80" (152 cm X 203 cm) absorbent drape with 2" X 5" (5 cm X 13 cm) fenestration. Sterile.

### Small Animal Extremity Drapes

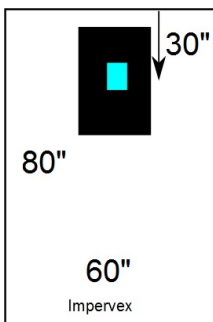

Product No. 3018

60" X 80" (152 cm X 203 cm) fenestrated Impervex drape. 20" X 30" (51 cm X 76 cm) absorbent reinforcement. 6" X 8" (15 cm X 20 cm) conformable panel 30" (76 cm) from drape top. Sterile.

Product No. 3019-1 (not pictured)

77" X 90" (196 cm X 229 cm) fenestrated spunlace drape. 20" X 30" (51 cm X 76 cm) absorbent reinforcement. 6" X 8" (15 cm X 20 cm) conformable panel 30" (76 cm) from drape top. Sterile.

Product No. 3028 (not pictured)

76" X 120" (193 cm X 305 cm) fenestrated SMS drape. 24" X 40" (61 cm X 102 cm) absorbent reinforcement. 1.25" (3 cm) fenestration in conformable panel. Sterile.

### Small Animal Leg Drapes

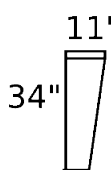

Product No. 2426

11" (28 cm) at top. 34" (86 cm) long. 2" (5 cm) cuff. Impervex. Sterile.

Product No. 2427 (not pictured)

9" (23 cm) at top. 22" (56 cm) long. 2" (5 cm) cuff. Impervex. Sterile.

Product No. 2428 (not pictured)

6" (15 cm) at top. 15" (38 cm) long. 2" (5 cm) cuff. Impervex. Sterile.

### Avian Drapes

Product No. 3101 (not pictured)

40" X 45" (102 cm X 114 cm) clear poly drape. 5" X 5" (13 cm X 13 cm) unfenestrated adhesive square centered on drape. Sterile.

Product No. 6059 (not pictured)

24" X 24" (61 cm X 61 cm) opaque poly drape. 5" X 5" (13 cm X 13 cm) adhesive square with 1.5" X 2" (4 cm X 5 cm) oval fenestration centered on drape. These drapes are great for myelograms. Sterile.

## Small Animal Arthroscopy Drape with Pouch

Product No. 6055 (pictured at right)  
 88" X 124" (224 cm X 315 cm) SMS drape. 36" (91 cm) triangular impervious reinforcement.  
 2.5" (6 cm) fenestration centered on mid-line. Sterile.

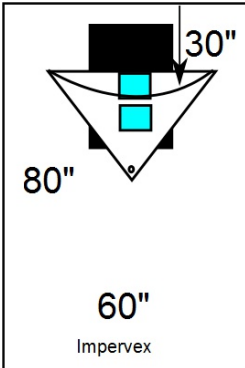
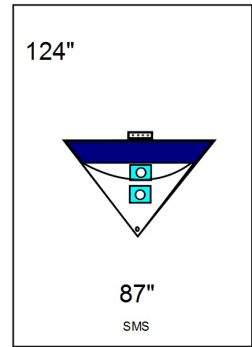

Product No. 6086 (pictured at left)  
 60" X 80" (152 cm X 203 cm) Impervex drape with integrated fluid collection pouch. Conformable panels in both drape and pouch face. Sterile.

Product No. 6016 (pictured at right)  
 20" X 20" (51 cm X 51 cm) arthroscopy fluid collection pouch. Attaches to drape with double sided tape and is held open by malleable strip. Sterile.

For unfenestrated drapes, please refer to page 3.

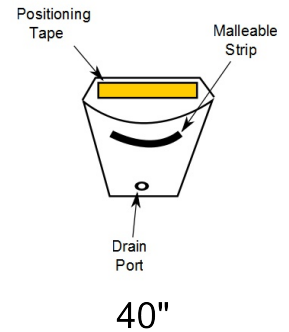

## Small Animal Eye Drapes

Product No. 6053  
 40" X 55" (102 cm X 140 cm) fenestrated spunlace drape. 2-5/8" (7 cm) round fenestration 11" (28 cm) from top of drape. 1.5" X 2" (4 cm X 5 cm) oval fenestration 11" (28 cm) from top of drape. Each fenestration centered in a 5" X 5" (13 cm X 13 cm) adhesive square. Sterile.

Product No. 6056 (not pictured)  
 Equine eye drape. 48" X 55" (122cm X 140 cm) wetlaid nonwoven drape with 5" X 5" (13 cm X 13 cm) adhesive center panel and 2" (5 cm) round opening 24" (61 cm) from top of drape. Sterile.

Product No. 6057 (not pictured)  
 40" X 55" (102 cm X 140 cm) fenestrated spunlace drape. 2" (5 cm) round fenestration in a 5" X 5" (13 cm X 13 cm) adhesive square 20" (51 cm) from top of drape. Sterile.

Product No. 6058 (not pictured)  
 40" X 55" (102 cm X 140 cm) fenestrated spunlace drape. 1.5" X 2" (4 cm X 5 cm) oval fenestration in a 5" X 5" (13 cm X 13 cm) adhesive square 20" (51 cm) from top of drape. Sterile.

Product No. 6060  
 40" X 60" (102 cm X 152 cm) fenestrated spunlace drape. 1.5" X 2" (4 cm X 5 cm) oval fenestration in a 5" X 5" (13 cm X 13 cm) adhesive square 20" (51 cm) from top of drape. 8" X 9" (20 cm X 23 cm) fluid collection pouch below fenestration. Sterile.

Product No. 6140 (not pictured)  
 Ophthalmology pouch. 8" X 9" (20 cm X 23 cm) pouch with double sided tape for positioning as required and malleable strip for holding pouch open. Sterile.

55"

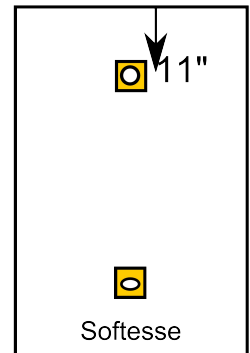

40"

55"

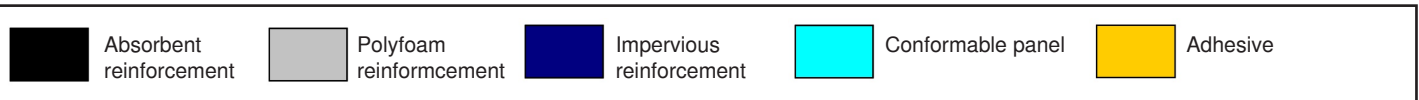
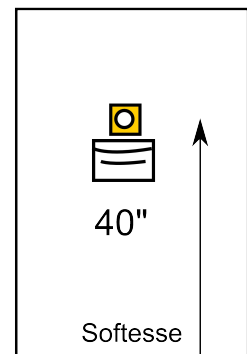





## Other Kits

### Small Animal Arthroscopy Kit

Product No. 5134

Contents:

#6055 – 88" X 124" SMS arthroscopy drape with pouch, 1 each.

#6029 – 24" X 26" Impervex towel drape, 4 each.

#2120 – XL extended procedure gown w/ towel, 1 each.

#3205 – 44" X 78" table cover, 1 each.

Sterile.

### Small Animal Total Hip Kit

Product No. 5111

Contents:

#6012-1 – 77" X 100" spunlace drape, 1 each.

#6025 – 18" X 26" wetlaid nonwoven towel drape, 4 each.

#3110 – 14" X 14" adhesive area incise drape, 1 each.

#3116 – 24" X 18" adhesive area IOBAN incise drape, 1 each.

#3220 – 23" X 54" Mayo stand cover, 1 each.

#3091 – 55" X 70" split sheet, 1 each.

#4007 – 1/4" X 10' suction hose, 1 each.

#4020 – 60 ml bulb syringe, 1 each.

4" X 4.1 yard Conform bandage, 1 each.

#3205 – 44" X 78" table cover, 1 each.

Sterile.

### Small Animal Total Hip Kit

Product No. 5211

Contents:

#3012-1 – 80" X 104" Impervex drape, 1 each.

#6038 – 30" X 30" Impervex towel drape, 4 each.

#3110 – 14" X 14" adhesive area incise drape, 1 each.

#3116 – 24" X 18" adhesive area IOBAN incise drape, 1 each.

#3220 – 23" X 54" Mayo stand cover, 1 each.

#3091 – 55" X 70" split sheet, 1 each.

#4007 – 1/4" X 10' suction hose, 1 each.

#4020 – 60 ml bulb syringe, 1 each.

4" X 4.1 yard Conform bandage, 1 each.

#3205 – 44" X 78" table cover, 1 each.

Sterile.

### Small Animal Ophthalmology Kit

Product No. 5099

Contents:

#6053 – 40" X 60" spunlace eye drape, 1 each.

#6034 – 22" X 30" SMS towel drape w/tape, 2 each.

Sterile.

This list is representative of our custom kit packing capabilities. Please call to arrange a quote for a custom kit for your practice



Absorbent reinforcement



Polyfoam reinforcement



Impervious reinforcement



Conformable panel



Adhesive

# Equine Orthopedic Drapes

## Unilateral Procedure Arthroscopy Drapes

Product No. 3064

140" X 200" (356 cm X 108 cm) Impervex drape. 20" X 30" (51 cm X 76 cm) polyfoam reinforcement on center line and 90" (229 cm) from top of drape. 4" X 12" (10 cm X 30 cm) unfenestrated conformable panel centered on reinforcing. Suction tubing holders. Sterile.

Kits using #3064: 5037 See page 12.

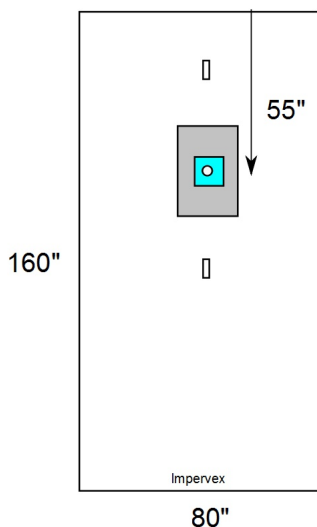
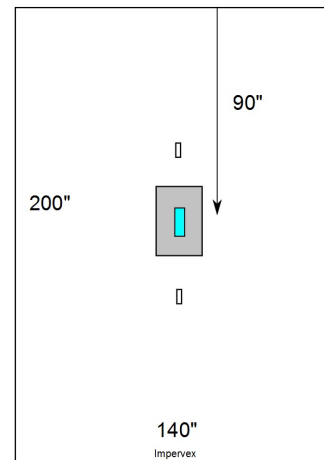

Product No. 3065

80" X 160" (203 cm X 406 cm) fenestrated Impervex drape. 20" X 30" (51 cm X 76 cm) polyfoam reinforcement on center line and 55" (140 cm) from top of drape. 3.5" (9 cm) fenestration in 10" X 10" (25 cm X 25 cm) conformable panel centered in reinforcing. Suction tubing holders. Sterile.

Kits using #3065: 5056, 5035 See page 12.

Product No. 6074 (not pictured)

140" X 160" (356 cm X 406 cm) fenestrated Impervex drape. 20" X 30" (51 cm X 76 cm) polyfoam reinforcement on center line and 55" (140 cm) from top of drape. 3.5" (9 cm) fenestration in 10" X 10" (9 cm) conformable panel centered in reinforcing. Suction tubing holders. Sterile.

Product No. 6047

87" X 126" (221 cm X 320 cm) fenestrated SMS drape. 20" X 38" (51 cm X 97 cm) polyfoam reinforcement on center line 2" X 3" (5 cm X 8 cm) oval fenestration in conformable panel centered in reinforcing. Suction tubing holders. Sterile.

Kits using #6047: 5147 See page 12.

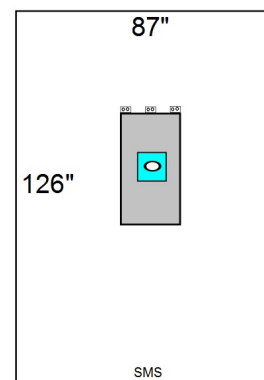

## Bilateral Procedure Arthroscopy Drapes

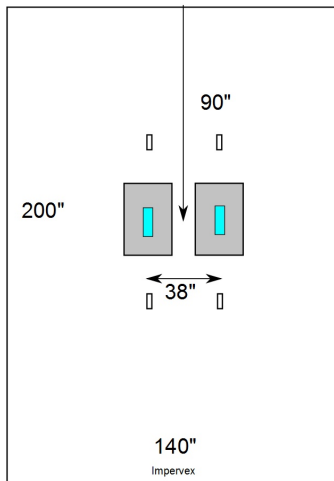

Product No. 3069 (pictured at left)

140" X 200" (51 cm X 76 cm) Impervex drape. Two 20" X 30" (51 cm X 76 cm) polyfoam reinforcements. Two 4" X 12" (10 cm X 30 cm) unfenestrated conformable panels 90" (229 cm) from top of drape, 38" (97 cm) apart, and centered on reinforcements.

Suction tubing holders. Sterile.

Kits using #3069: 5038 See page 12.

Product No. 3066 (pictured at right)

120" X 160" (305 cm X 406 cm) fenestrated Impervex drape. Two 20" X 30" (51 cm X 76 cm) polyfoam reinforcements. Two 10" X 10" (25 cm X 25 cm) conformable panels with 3.5" (9 cm) fenestrations 55" (140 cm) from top of drape and with 38" (97 cm) separation around mid-line. Suction tubing holders. Sterile.

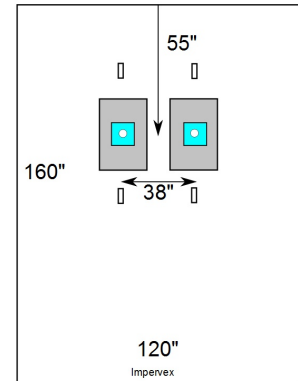

Drape kits using #3066: 5036 See page 12.

## Equine Arthroscopy/IV Fluid Cuff

Product No. 3417

Arthroscopy/IV fluid cuff for 5 L fluid bag. Hand inflator with pressure gauge. Washable heavy duty cotton cuff. Chrome plated manometer. Transparent net allow fluid level monitoring.

Product No. 3432

Arthroscopy/IV fluid cuff for 3 L fluid bag. Hand inflator with pressure gauge. Washable heavy duty cotton cuff. Chrome plated manometer. Transparent net allow fluid level monitoring.

Product No. 3410

Electric compressor for inflation of arthroscopy cuff. Compatible with US and European electrical systems. Allows controlled inflation at the touch of a foot switch.

Product No. 3411

Electric compressor for inflation of dual arthroscopy cuffs. Compatible with US and European electrical systems. Allows controlled inflation at the touch of a foot switch.



## Irrigation Sets

Product No. 3400

Dual line high volume irrigation set. 8' (244 cm) long. Sterile.

Product No. 3401

Single line high volume irrigation set. 8' (244 cm) long. Sterile.

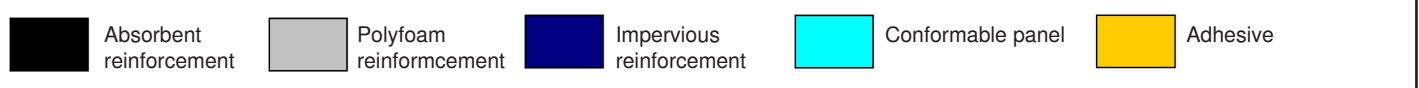

# Large Animal Specialty Sheets

## Equine Cryptorchid/Celiotomy Drapes

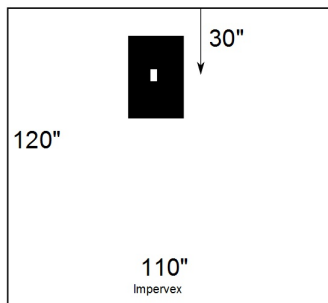

Product No. 3071

Equine cryptorchid/celiotomy drape. 110" X 120" (279 cm X 305 cm) fenestrated Impervex drape. 20" X 30" (51 cm X 76 cm) absorbent reinforcement. 3" X 5" (8 cm X 13 cm) fenestration at drape mid-line and 30" (76 cm) from drape top. Sterile.

Product No. 3072 (not pictured)

Equine cryptorchid/celiotomy drape. 110" X 140" (279 cm X 356 cm) fenestrated Impervex drape. 20" X 30" (51 cm X 76 cm) absorbent reinforcement. 3" X 7" (8 cm X 18 cm) fenestration at drape mid-line and 45" (114 cm) from drape top. Sterile.

## Equine Eye Drapes

Product No. 3055 (not pictured)

Equine eye drape. 40" X 40" (102 cm X 102 cm) Impervex drape with 5" X 5" (13 cm X 13 cm) adhesive center panel and 3" (8 cm) round opening. Sterile.

Product No. 3056

Equine eye drape. 65" X 65" (165 cm X 165 cm) wetlaid nonwoven drape with 5" X 5" (13 cm X 13 cm) adhesive center panel and 3" (8 cm) round opening. Sterile.

Product No. 6056 (not pictured)

Equine eye drape. 48" X 60" (8 cm) wetlaid nonwoven drape with 5" X 5" (13 cm X 13 cm) adhesive center panel and 2" (5 cm) round opening 24" (61 cm) from top of drape. Sterile.

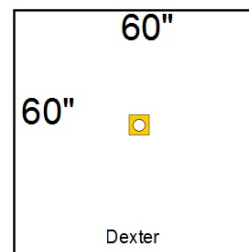

## Equine Throat Drape

Product No. 3060

Equine throat drape. 80" X 160" (203 cm X 406 cm) fenestrated Impervex drape. 20" X 30" (51 cm X 76 cm) absorbent reinforcement. 2" X 5" (5 cm X 13 cm) fenestration on drape mid-line and 54" (137 cm) from drape top. Sterile.

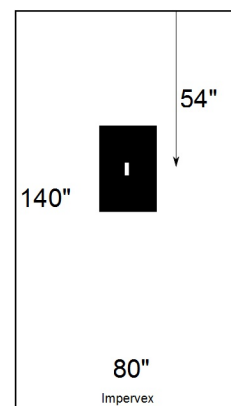

## Equine Leggings

Product No. 5082 (not pictured)

Equine leggings. SMS material. 31" X 48" (76 cm X 122 cm) with 6" (18 cm) cuff. 2 per package. Sterile.



## Large Animal Orthopedic Kits

Kits on this page are normally stocked and small quantities are usually available at the time of ordering. Other kits may be special ordered. Kits are over wrapped and sealed in header pouches. This list is representative of our custom kit packing capabilities. Please call to arrange a quote for a custom kit for your practice.

Product No. 5035  
 #3065 – arthroscopy drape, 1 each.  
 #3010 – 40" X 60" Impervex drape, 2 each.  
 #3205 – 44" X 78" table cover, 1 each.  
 Sterile.

Product No. 5036  
 #3066 – arthroscopy drape, 1 each.  
 #3010 – 40" X 60" Impervex drape, 4 each.  
 #3205 – 44" X 78" table cover, 1 each.  
 Sterile.

Product No. 5037  
 #3064 – arthroscopy drape, 1 each.  
 #3205 – 44" X 78" table cover, 1 each.  
 Sterile.

Product No. 5038  
 #3069 – arthroscopy drape, 1 each.  
 #3010 – 40" X 60" Impervex drape, 2 each.  
 #3135 – 4" X 18.5" tape strip, 2 each.  
 #3205 – 44" X 78" table cover, 1 each.  
 Sterile.

### Custom Surgical Drape Kits

As a custom drape and kit manufacturer, we specialize in designing and building drapes and kits that meet each surgeon's precise requirements. Designing a kit to meet your needs is simple. Most items listed in our catalog may be included as components in a custom kit. Please call with your requirements and Vet. Surgical Resources will provide a custom kit.

Custom disposable drape kits bring many benefits to a practice: convenience, lower processing costs, and shorter prep times to name a few. Please call to see how custom kits from Vet. Surgical Resources can benefit your practice.







Product No. 5039  
 Copelan orthopedic kit  
 #3030 – 140" X 160" Impervex drape, 1 each.  
 #3010 – 40" X 60" Impervex drape, 4 each.  
 #3205 – 44" X 78" table cover, 1 each.  
 Sterile.

Product No. 5056  
 #3065 – arthroscopy drape, 1 each.  
 #3205 – 44" X 78" table cover, 1 each.  
 Sterile.

Product No. 5058  
 #3066 – arthroscopy drape, 1 each.  
 #3205 – 44" X 78" table cover, 1 each.  
 Sterile.

Product No. 5070  
 #3065 – arthroscopy drape, 2 each.  
 #3010 – 40" X 60" Impervex drape, 4 each.  
 #3205 – 44" X 78" table cover, 1 each.  
 Sterile.

Product No. 5147  
 #6047 – arthroscopy drape, 1 each.  
 #3205 – 44" X 78" table cover, 1 each.  
 Sterile.

	Absorbent reinforcement		Polyfoam reinforcement		Impervious reinforcement		Conformable panel		Adhesive
---	-------------------------	---	------------------------	---	--------------------------	---	-------------------	---	----------

# Large Animal Laparotomy Sheets

## Large Animal Laparotomy Sheets with Enterotomy Pouches

All laparotomy sheets are assembled using Impervex material. Fenestrations are centered in drape. Enterotomy pouch is 36" X 40" (91 cm X 102 cm) with plastic interior to minimize sticking of the bowel and allows the surgeon to easily contain the bowel. Top reinforcement is also plastic to minimize sticking of the bowel if the pouch is not used. 4" X 14" (10 cm X 36 cm) fenestration with 2" (5 cm) adhesive. Laparotomy sheets are available with the #3205 44" X 78" (112 cm X 198 cm) table cover. All drapes are available as a component of a custom kit.

Product Number	Overall Size (W X L)	Fenestration Size	Product Number w/ Table Cover
3087	80" X 165" (203 cm X 419 cm)	4" X 14" (10 cm X 36 cm)	5174
3088	120" X 160" (305 cm X 406 cm)	4" X 14" (10 cm X 36 cm)	5191
3089	140" X 210" (356 cm X 533 cm)	4" X 14" (10 cm X 36 cm)	5192

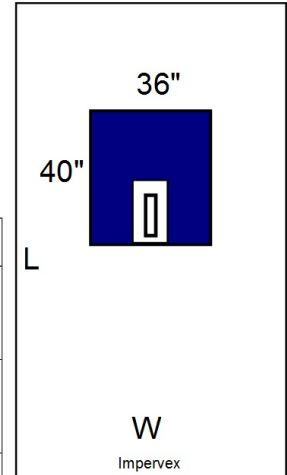

## Large Animal Laparotomy Sheets

All laparotomy sheets are assembled using Impervex material. Fenestrations are centered in drape. #3070 features an absorbent reinforcement while the #3080, #3083 and #3085 feature a plastic coated reinforcement to minimize sticking of the bowel. Laparotomy sheets are also available with tape around the fenestration. Please call for availability of these special order items. Laparotomy sheets are available with the #3205 44" X 78" (112 cm X 198 cm) table cover or as custom kits as well.

Product Number	Overall Size (W X L)	Fenestration Size	Product Number w/ Table Cover
3070 RDA Sheet	80" X 110" (203 cm X 279 cm)	3" X 7" (8 cm X 18 cm)	5065
3080 Tullener's Sheet	80" X 160" (203 cm X 406 cm)	4" X 14" (10 cm X 36 cm)	5107
3081	80" X 160" (203 cm X 406 cm)	3" X 7" (8 cm X 18 cm)	
3085	140" X 210" (356 cm X 533 cm)	4" X 14" (10 cm X 36 cm)	3086
3083	180" X 210" (457 cm X 533 cm)	4" X 14" (10 cm X 36 cm)	

## Laparotomy Accessories

Product No. 3103  
23" X 53" (58 cm X 135 cm) clear plastic enterotomy tray cover for Shank's table. Sterile.

Product No. 3104  
40" X 45" (102 cm X 114 cm) plastic enterotomy tray cover. 5" X 5" (13 cm X 13 cm) adhesive square in center to adhere cover to tray. Sterile.

## Viscera Retainers

Product No. 4053  
Viscera retainer. 9" (23 cm) maximum width and 14" (36 cm) long with pull strap. Radio-opaque. Single use. Sterile.

Product No. 4054  
Viscera retainer. 6" (14 cm) maximum width and 9" (36 cm) long with pull strap. Radio-opaque. Single use. Sterile.

## Split Sheets / Incise Drapes / Impervious Stockinette

Product No. 3090

60" X 80" (152 cm X 203 cm) Impervex split sheet. 20" X 30" (51 cm X 76 cm) polyfoam reinforcement. 6" X 24" (15 cm X 61 cm) split. Sterile.

Product No. 3092

60" X 80" (152 cm X 203 cm) Impervex split sheet. 20" X 30" (51 cm X 76 cm) polyfoam reinforcement. 6" X 24" (15 cm X 61 cm) split with 1" (3 cm) tape around split. Sterile.

Product No. 3091

60" X 70" (152 cm X 178 cm) plastic split sheet. 4" X 21" (152 cm X 178 cm) split with 2" (5 cm) tape around split. Sterile.

Product No. 3095

80" X 140" (203 cm X 356 cm) Impervex split sheet. 20" X 30" (51 cm X 76 cm) polyfoam reinforcement. 6" X 44" (15 cm X 112 cm) split. Sterile.

Product No. 3096

80" X 140" (203 cm X 356 cm) Impervex split sheet. 20" X 30" (51 cm X 76 cm) polyfoam reinforcement. 6" X 44" (15 cm X 112 cm) split with 2" (5 cm) tape around split. Sterile.

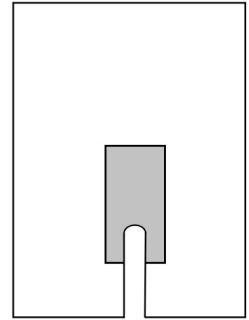

### Incise Drapes

Incise drapes are thin plastic drapes with an adhesive coating on one side. The drape is applied to the surgical site and the incision made through the drape. The drape provides a sterile field and the adhesive prevents skin microbes from entering the incision. Adhesives may be impregnated with antimicrobial solution. Vet. Surgical Resources offers 3M incise drapes in several sizes with and without antimicrobial solution. 3M antimicrobial incise drapes are marketed under the Ioban 2™ brand. Plain 3M drapes are marketed under the Steri-Drape™ brand.

Adhesive Area	3M Healthcare			
	Steri-Drape	3M Number	IOBAN 2	3M Number
23" X 33" (60 cm X 85 cm)	3105	1051	3106	6651EZ
23" X 23" (60 cm X 60 cm)			3122	6648EZ
13" X 13" (35 cm X 35 cm)	3110	1040	3112	6640EZ
17" X 23" (45 cm X 60 cm)	3115	1050	3116	6650EZ
4" X 8" (10 cm X 20 cm)			3131	6635

### Impervious Stockinette

Impervious stretch outer barrier and woven polyester stockinette interior. Sterile. (1/pkg)

Size	Lay Flat Width	Unstretched Diameter	Product Number
3" X 15" (8cm X 15 cm)	3" (8cm)	1.9" (5 cm)	2430
5" X 20" (13 cm X 51 cm)	5" (13 cm)	3.2" (8 cm)	2432
7" X 48" (18 cm X 122 cm)	7" (18 cm)	4.5" (11 cm)	2420
9" X 48" (23 cm X 122 cm)	9" (23 cm)	6" (15 cm)	2425
12" X 48" (30 cm X 122 cm)	12" (30 cm)	8" (20 cm)	2429

# Towel Drapes / Table Covers / Sponges

## Towel Drapes

Towel drapes are available non-sterile or packaged four in a Tyvek pouch and sterile.

Size (in.)	Size (cm)	Drape Material		
		Wetlaid nonwoven	Spunlace	Impervex *
18" X 26"	46 X 66	6025		
18" X 26" w/ tape	46 X 66	6020		
22" X 30"	56 X 76		6022	
22" X 30" w/ tape	56 X 76		6034	
24" X 26"	61 X 66	6027		6029
24" X 26" w/ tape	61 X 66	6026		6036
27" X 30"	66 X 76			6038
30" X 30"	76 X 76		6094	
36" X 36"	91 X 91		6095	
36" X 36" w/ tape	91 X 91		6095T	
36" X 40"	91 X 102		6096	

\* Impervex material is not autoclavable.

### Table Covers

Product No. 3205

44" X 78" (112 cm X 198 cm) blue plastic table cover with 24" (61 cm) wide full length centered SMS lamination. Fan-folded. Sterile. (1/pkg).

Product No. 3206

44" X 44" (112 cm X 112 cm) blue plastic table cover with 24" (61 cm) wide full length centered SMS lamination. Fan-folded. Sterile. (1/pkg).

Product No. 3207

50" X 90" (127 cm X 229 cm) blue plastic table cover with 24" (61 cm) wide full length centered SMS lamination. Fan-folded. Sterile. (1/pkg).

### Laparotomy Sponges

Pre-washed 8 ply lap sponges with radio-opaque loops.

Size	Non-sterile (5/pkg.)	Sterile (2/pkg.)
4" X 18" (10 cm X 46 cm)	2228	2229
12" X 12" (30 cm X 30 cm)	2234	2232
18" X 18" (46 cm X 46 cm)	2230	2225
36" X 36" (91 cm X 91 cm)	2227 (1/pkg.)	2226 (1/pkg.)

### Set-up Cover

Product No. 3210

54" X 90" (109 cm X 229 cm) clear plastic set-up cover. Fan-folded. Sterile. (1/pkg).

### Mayo Stand Cover

Product No. 3220

54" X 23" (137 cm X 58 cm) blue plastic Mayo stand cover with 20" X 26" (51 cm X 66 cm) SMS reinforcement and 7" (18 cm) cuff. Sterile. (1/pkg).

Size	Regular Procedure		Extended Procedure	
	Spunlace	SMS	Spunlace	SMS
Small		2104		2102
Large	2105	2105-2, 2106	2115	2103
X-Large	2110	2110-1, 2113	2120	2116
XX-Large		2108		2111

### Regular Procedure Gowns

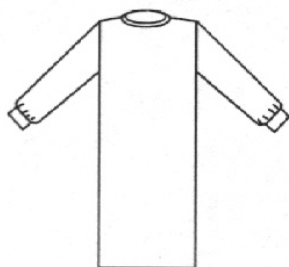

Regular procedure gowns are non-reinforced sterile-back type SMS or spunlace gowns with hook and loop neck closure. Each is individually wrapped and packaged with a hand towel. Sterile. Gowns are also available in custom kits. AAMI certification level information is available at [www.vetsurgicalresources.com](http://www.vetsurgicalresources.com).

#### **Small**

Product No. 2104

Small regular procedure gown. SMS material with hook and loop neck closure and hand towel.

#### **Large**

Product No. 2105

Large regular procedure gown. Spunlace material with hook and loop neck closure and hand towel.

Product No. 2105-2

Large regular procedure gown. SMS material with hook and loop neck closure, Raglan sleeves, and hand towel.

Product No. 2106

Large regular procedure gown. SMS material with hook and loop neck closure and hand towel.

#### **X-Large**

Product No. 2110

X-Large regular procedure gown. Spunlace material with hook and loop neck closure and hand towel.

Product No. 2110-1

X-Large regular procedure gown. SMS material with hook and loop neck closure, Raglan sleeves, and hand towel.

Product No. 2113

X-Large regular procedure gown. SMS material with hook and loop neck closure and hand towel.

#### **XX-Large**

Product No. 2108

XX-Large regular procedure gown. SMS material with hook and loop neck closure, Raglan sleeves, and hand towel.



## O. R. Gowns



### **Extended Procedure Gowns**

Extended procedure gowns are reinforced internally or externally with impervious plastic or fabric and are sterile-back type. They are constructed of SMS or spunlace medical fabric and feature hook and loop neck closure. Sterile. AAMI certification level information is available at [www.vetsurgicalresources.com](http://www.vetsurgicalresources.com).

### **Small**

Product No. 2102

Small extended procedure gown. Internal fabric reinforcement. SMS material with hook and loop closure, Raglan sleeves, and hand towel.

### **Large**

Product No. 2115

Large extended procedure gown. Internal impervious reinforcement. Spunlace material with hook and loop neck closure and hand towel.

Product No. 2103

Large extended procedure gown. External impervious reinforcement. SMS material with hook and loop neck closure and hand towel. Popular for equine colic surgery.

### **X-Large**

Product No. 2120

X-large extended procedure gown. Internal impervious reinforcement. Spunlace material with hook and loop neck closure and hand towel.

Product No. 2116

X-large extended procedure gown. External impervious reinforcement. SMS material with hook and loop neck closure and hand towel. Popular for equine colic surgery.

### **XX-Large**

Product No. 2111

XX-Large extended procedure gown. Internal fabric reinforcement. SMS material with hook and loop neck closure and hand towel.

### **Colic Gowns**

Vet Surgical Resources' gowns offer breathable comfort and impervious protection to the wearer. The state of the art fabric reacts with body heat to allow moisture to pass through it, keeping the user cool and dry during long, wet surgeries. The outer impervious layer provides a viral barrier as well as traditional barrier properties. A soft interior layer ensures comfort to the user. This fabric is designed to meet or exceed AAMI Level 4 protection. Sterile.

### **Small**

Product No. 2122

Small, impervious, breathable material colic gown with hand towel.

### **Large**

Product No. 2123

Large, impervious, breathable material colic gown with hand towel.

### **Large, X-Long**

Product No. 2101

Large, X-Long, impervious, breathable material colic gown with hand towel.

### **X-Large, X-Long**

Product No. 2100

X-Large, X-Long, impervious, breathable material colic gown with hand towel.

**Sleeves**

Product No. 2125

29" (74 cm) lightweight plastic sleeve with elastic top. Locks to all fingers. Includes tape to seal sleeve to surgeon's glove. Sterile. (1 pair/pkg).

**Surgeon's Caps**

Product No. 2130

Blue surgeon's cap with ties. Non-sterile. (100/bx).



**Surgeon's Mask**

Product No. 2135

Fog free surgeon's mask with ties. Latex free with polypropylene outer liner and cellulose inner liner. Non-sterile. (50/bx).

**Surgeon's Beard Cover**

Product No. 2140

White beard cover with elastic head band. Non-sterile. (100/bx).

**Surgeon's Hood**

Product No. 2145

Blue surgeon's hood/beard cover with ties. SMS material. Non-sterile. (50/bx).



**Bouffant Caps**

Product No. 2150

21" (53 cm) blue bouffant caps. Spunbonded material. Non-sterile. (100/bx).



**Shoe Covers**

Product No. 2155

Universal size blue shoe cover. Non-skid sole. Non-sterile. (50 pair/bx).



Product No. 2160

High-top shoe cover. White Tyvek with non-skid sole. Non-sterile. (25 pair/bx).



## Equipment Covers

### ***Drill Shroud***

Product No. 2700

Disposable Impervex drill shroud for Makita drill. Individually sterilized. Adhesive closure. (5/pkg).

### ***Bone Saw Covers***

Product No. 2705

Telescoping cover for air or electric powered Slocum motor and cord/hose. Eliminates need to ETO sterilize saw motor unit and cord. 90" (229 cm) length. Fits Slocum models 716 OSE and 714 OS. Also fits the Stryker reciprocating saw motor. Sterile.

### ***Battery Cover***

Product No. 2716

Disposable battery cover for battery operated drills. Eliminates need for autoclavable cover and helps prevent accidental autoclaving of batteries. Sterile.

### ***X-ray Cassette Covers***

Product No. 3805

Cassette cover for 8" X 10" (20 cm X 25 cm) or 10" X 12" (25 cm X 30 cm) film. Cover has cuff and adhesive closure. Sterile. (2/pkg).

Product No. 3806

Cassette cover for 14" X 17" (36 cm X 43 cm ) film. Cover has cuff and adhesive closure. Sterile. (2/pkg). Also available in single pack as product number 3806-1.

Product No. 3813

24" X 38" (61 cm X 97 cm)Cassette cover for larger wireless digital receptors. Cover has cuff. Sterile. (2/pkg).

Product No. 3814

24" X 26" (61 cm X 66 cm) Cassette cover for larger wireless digital receptors. Cover has cuff and adhesive closure. Sterile. (1/pkg).

### ***C Arm X-ray Machine Covers***

Product No. 3810

C arm x-ray machine cover for isolating machine in OR. 38" X 63" (97 cm X 160). Sterile.

### ***Light Handle Covers***

Product No. 2740

Light handle cover. Sterile. (2/pkg).

## Equipment Covers / Suction Components / Miscellaneous O.R. supplies

### **Flouroscope Cover**

Product No. 3850  
Flouroscope cover. 36" X 44" (91 cm X 112 cm) clear anti-static plastic cover with tape. Sterile.

### **Video Camera Cover**

Product No. 3860  
Video camera cover. 5" X 96" (13 cm X 244 cm) telescoping cover for camera and cable. Includes tape strip for closure. Sterile.

### **Suction Hose**

1/4" (6 mm) inside diameter flexible PVC tubing with female ends. Sterile. (1/pkg).

Length (ft.)	Length (cm)	Product No.
6	183	4006
8	244	4008
10	305	4007
12	366	4005

### **Suction Adapters**

Product No. 4010  
Adapts 1/4" (6 mm) female suction line to male luer needle. Individually sterilized. (10/pkg).

### **Suction Handles**

Product No. 4015  
Poole suction handle with dual action tip. Sterile.

Product No. 4016  
Yankauer non-vented suction handle with bulb tip. Sterile.

### **Syringes**

Product No. 4020  
60 mL Bulb syringe. Sterile.

Product No. 4021  
2 oz. (60 mL) Ear syringe. Sterile.

### **Fiber Optic Light Cover**

Product No. 3865  
Fiber optic light cover. 5" X 36" (13 cm X 92 cm) long to cover light head and bundle. Includes tape strip for closure. Sterile.

### **Ultrasound Cover**

Product No. 3870  
Ultrasound probe cover. 5" X 96" (13 cm X 244 cm) telescoping to cover probe and cable. Sterile.

### **Adhesive Strips**

Product No. 3135  
Adhesive strips. 4" X 24" (10 cm X 61 cm). Blue polywith release liner. Sterile. (2/pkg).

### **Instrument Sorters**

Product No. 4040  
6 pocket polyfoam instrument sorters. 2" X 1.5" (5 cm X 4 cm) pockets with flap. Pockets are perforated and may be separated. Autoclavable. (2/pkg.)

Product No. 4041  
1 pocket polyfoam instrument sorters. 6.75" X 4" (17 cm X 10 cm) pocket. Autoclavable. (2/pkg.)

### **Sponge Bowls and Trays**

Product No. 4070  
1000 cc sponge bowl. ETO sterilize only. Non-sterile.

Product No. 4071  
500 cc sponge bowl. ETO sterilize only. Non-sterile.

Product No. 4072  
1200 cc pitcher. ETO sterilize only. Non-sterile.

Product No. 4073  
9.72" X 11" X 2" tray. ETO sterilize only. Non-sterile.

### **Gauze Squares**

3" X 3" (8 cm X 8 cm) 12 ply gauze squares in packs of 10.  
Product No. 2235NS (10/pkg). Non-sterile.

4" X 4" (10 cm X 10 cm) 16 ply gauze squares in packs of 10. Radio opaque.  
Product No. 2238NS (10/pkg). Non-sterile.  
Product No. 2238 (10/pkg). Sterile.

### **Cautery Pencil**

Product No. 4060  
Cautery pencil with push button and holster. Sterile.

## Miscellaneous O. R. Supplies

### *Tubular Stockinette*

25 yard roll. Polyester material. Non-sterile.  
 Product No. 2405 3" X 25yd. (8 cm X 23 m)  
 Product No. 2410 4" X 25yd. (10 cm X 23 m)  
 Product No. 2415 6" X 25yd. (15 cm X 23 m)

### *OR Towels*

17" X 27" (16 cm X 25 cm) pre-washed blue cotton OR towel.  
 Product No. 2205 (2/pkg). Sterile.  
 Product No. 2206 (4/pkg). Sterile  
 Product No. 2210 (5/pkg). Non-sterile.

17" X 24" (16 cm X 61 cm) non-woven absorbent OR towel. Low linting.  
 Product No. 2211 (1 ea.) Non-sterile.

### *Sterilization Pouches*

Paper self-sealing pouches with chevron opening and steam and ethylene oxide sterilization indicators. Pouch is constructed of heavy medical grade paper backing and blue tinted plastic front. Suitable for EO sterilization and autoclaving.

Size (in.)	Size (cm)	Pouches / pkg.	Product Number
2.25" X 5.25"	6 X 13	200	3300
3.5" X 10"	9 X 25	200	3305
3.5" X 6.5"	9 X 17	200	3315
5.25" X 11"	13 X 28	200	3320
7.5" X 13"	19 X 33	100	3325
12" X 15"	30 X 38	100	3330

### *Esmark Bandages*

Available wrapped and sterile or non-sterile. 0.15" (4 mm) thick latex. (1/pkg).

Size	Size	Sterile Product No.	Non-sterile Product No.
3" X 9 ft.	8 cm X 2.75 m	4030	4030NS
4" X 12 ft.	10 cm X 3.65 m	4031	4031NS
6" X 12 ft.	15 cm X 3.65 m	4033	4033NS

### *Sterilization Wrap*

Sterilization wrap is used in the sterilization of instruments, kits, and devices for patient care. Dextex™ wrap is compatible with steam, ethylene oxide, and gamma irradiation sterilization processes. Wrap is designed for single use and should be inspected prior to use. Wrap is available in Dextex. 45" (114 cm) wrap is available in SMS.

Size (in.)	Size (cm)	Sheets/pkg.	Product No.
20" X 20"	51 X 51	50	3176
24" X 24"	61 X 61	50	3180
30" X 30"	76 X 76	25	3184
36" X 36"	91 X 91	25	3185
45" X 45"	114 X 114	25	3190





**Vet. Surgical Resources, Inc.**

PO Box 368

Darlington, MD 21034

Phone, Continental USA & Canada: **1-800-354-8501**

Fax or Phone: **1-410-457-5616**

Web Site: ***www.vetsurgicalresources.com***

Email: ***wecare@vetsurgicalresources.com***